





# AT 510 ALUMINIUM-HAUSEINGANGSTÜR



## EIGENSCHAFTEN

	<b>Wärmedämmung</b>	bis $U_b = 0,95 \text{ W/(m}^2\text{K)}$
	<b>Schallschutz</b>	bis 38 dB
	<b>Sicherheit</b>	bis RC2
	<b>Verriegelung</b>	Mehrfach-Verriegelung
	<b>Bautiefe</b>	93 mm

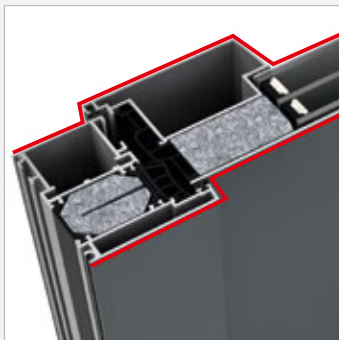

Innen profiliert  
Außen kantig



Plattenaufbau mit Isolierglaskern  
für ausgezeichnete Klimastabilität

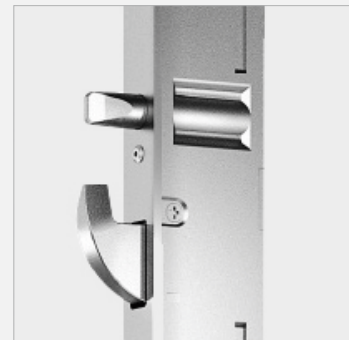

5-fach Verriegelung im Standard  
für höchste Sicherheit

Schnitte

Schnitt unten

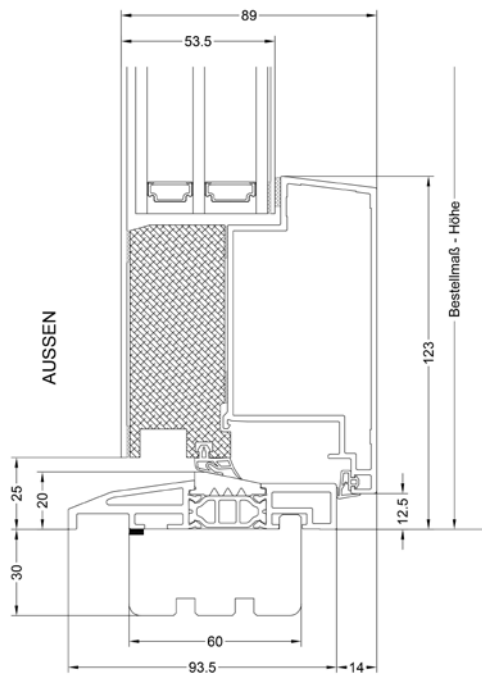

Schnitt seitlich, oben

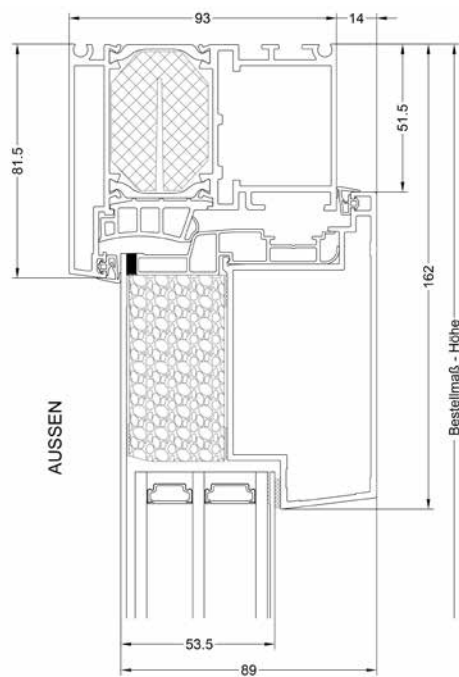

PG



PM



GD



GA

Weitere Modelle finden Sie im Türendesigner:

